



# Cubnut

Φ5 x 3 mm U8



Unlike flexible sticker-style RFID labels, these tags use PCB technology for the antenna and circuitry and are constructed rigid material, making them extremely robust, compact, and often optimized for challenging environments — especially when attached to metal surfaces, tools, industrial equipment, or harsh conditions (high temperature, humidity, impact, vibration etc).

With multiple mounting options and support for global UHF RFID standards, this RFID PCB tag integrates seamlessly into existing systems, offering accurate identification, improved visibility, and reduced operational costs.

## Highlights & Benefits

- ✓ Outstanding performance
- ✓ Durable PCB construction for long term usage
- ✓ Multiple mounting options for installation
- ✓ ETSI(865-868 MHz) and FCC(902-928 MHz) optional
- ✓ Customization-design, printing, encoding available

## Applications

- ✓ Device & tool
- ✓ Electronics
- ✓ Mould
- ✓ Metal part



## Technical Features

Model	RCP8020
<b>RFID Features</b>	
Air Interface Protocol	EPC Class 1 Gen 2 / ISO 18000-63 Type C
Frequency	860-960 MHz
Chip Type	NXP Ucode 8
Memory	User - N/A; EPC - 128 bits; TID - 96 bits
Data Storage	> 10 years
Re-write	100,000 times
Read Range(2W ERP)	FCC: > 3.0 m(9.8 ft) , on metal ETSI: > 4.5 m(14.8 ft) , on metal
<b>Physical Features</b>	
Dimension	D=5 x 3 mm / 0.20 x 0.12 in
Material	FR-4
Weight	0.12 g
Color	Black
Operating Temperature	-40°C to 85°C / -40°F to 185°F
Survival Temperature	-40°C to 150°C / -40°F to 302°F
Storage Condition	20±5°C, 50±10% RH, Store away from sunlight
IP Rate	IP68, test for 5 hours at 1m deep water
<b>Other Features</b>	
Installation	Adhesive(clean and dry surface), Rivet, Magnet, Screw
Customization	Encoding, Design, etc.
Package	1,000 pcs / bag, 10 bags / box

### Radiation Pattern

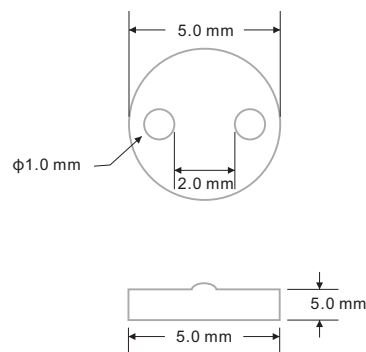
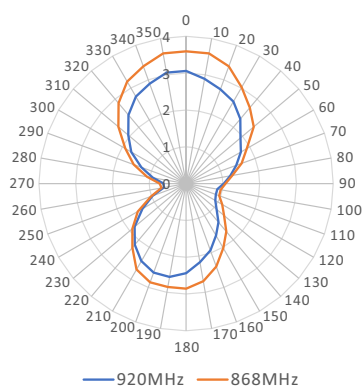

PS: The performance is theoretical values in the lab and the actual effect depends on the specific applications.

**RICHRFID**

Web: <https://www.richrfid.com> E-mail: [info@richrfid.com](mailto:info@richrfid.com)  
Shenzhen | Hong Kong | Singapore | Seoul | Tokyo | Paris



#### DISCLAIMER

All specifications are indicative and results may vary. Each user bears full responsibility for making its own determination as to the suitability of RICHRFID products, materials, services, recommendations, or advice for its own particular use.

For intended use only. Not to be repurposed or used for other applications without prior written permission from the manufacturer.

@2026 RICHRFID. All rights reserved.